

Residential Solar and Battery Systems EG Application Single Line Diagram Requirements

Purpose:

The requirements in this document apply to Single Line Diagram (SLD) for negotiated connection applications at Jemena, including:

- Limited export
- Residential solar and battery systems
- Case 3,4,10 and 11 from Jemena's 'solar-and-renewables-for-installers-recs' website <https://jemena.com.au/electricity/our-services/solar-and-renewables-for-installers-recs>

Case	Total Solar inverter Installation	Total Battery inverter Installation	Central Protection	Process	Approx. Fees (excl GST)	Conditions
3	10 kVA or less per phase	10 kVA or less per phase	Not Required	Negotiated	~\$550	Maximum export 5 kVA
4	5 kVA or less per phase	6-10 kVA per phase	Not Required	Negotiated	~\$550	Maximum export 5 kVA
10	Solar <30 kVA + Battery total aggregate solar + battery 40 kVA or less (3phase)		Not Required	Negotiated	~\$550	Maximum export 15 kVA
11	Solar 30 kVA + Battery 10 kVA or less (3phase)		Not Required	Negotiated	~\$550	Maximum export 15 kVA

The agreed SLD will be included in the connection agreement schedules.



GENERAL

The following will not be accepted:

- Hand drawn sketches
- Single line diagrams with incorrect information (addresses, solar panel / inverter model number, etc)
- Single line diagrams which do not align with the information on the online application form (unless a comment is made in online application or in email about the reason of the difference).

SINGLE LINE DIAGRAM REQUIREMENTS

The single line diagram shall (see attached SLDs as examples):

- Include a title block containing:
 - Drawing name
 - Unique drawing number
 - Version number
 - Designer and authoriser
 - Date
 - NMI Address
- Be in electronic format (not hand sketched). Common software to prepare SLD include Auto Cad, Microsoft Visio
- Preferably use symbols which comply with AS/NZS 3000 Appendix J Figure J1 (attached)
- Match all online application details (i.e. total system size (kVA), number of panels, number of inverters, number of batteries, model numbers, etc)
- Include the wiring from the panels to the connection point or supply meter
- Show symbol of point of supply/ boundary to Jemena network and supply meter
- Identify and name each switchboard involved (MSB, DB, PVDB etc)
- Show indicative customer loads circuits when present
- Ensure main solar switch and main battery switch are 'pad-lockable' and both are labelled
- Show phases involved in the proposed system and total phases at each switchboard (single phase or three phases)
- Clearly show the full connection and implementation of the system within the site including all CT/VT connections, contactors, circuit breakers, isolators, sub-boards, communication links, energy management system connections and export limit control measurement and connections, etc

- Show the manufacturer/model and full model number for each inverter, panel, relay, generator, etc
- Show capacity of battery inverter in kVA and in kWh
- Show total export limit of site, export limit of solar inverters, export limit of battery inverters
- Label what is existing solar/battery installation and what is new solar/battery installation on site

AS/NZS 3000 APPENDIX J FIGURE J1

Copyrighted material distributed by SAI Global and licensed to JEMENA ASSET MANAGEMENT PTY LTD on 09/28/2021 05:04:04.
 Reproduction, distribution, storage or use on a network is prohibited. Authorised user: andy.dickinson@jemena.com.au.

AS/NZS 3000:2018

544

















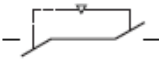













	Switch (general symbol)		Transformer (single line)
	Disconnecter (isolator)		Three-phase transformer secondary
	Switch-disconnector (on-load isolating switch)		Single-phase transformer
	Mechanically interlocked changeover switch		Three-phase alternator
	Fuse		Alternator
	Circuit breaker		Single-phase alternator
	Circuit breaker, earth leakage type, current operated (RCD)		PV array
	Protective-device providing overload and short-circuit protection		Battery.
	Protective-device providing overload protection only		Inverter
	Protective-device providing short-circuit protection only		Alternating current motor
	Protective earth neutral (PEN) conductor		3 pin socket outlet or cord extension socket
	Neutral conductor (N)		3 pin socket inlet or plug
	Protective earthing conductor (PE)		5 pin socket outlet or cord extension socket
	Connection to earth		5 pin socket inlet or plug
	Generator frame connection		Installation coupler
	Earth or neutral bar		

FIGURE J1 SYMBOLS USED IN THIS STANDARD

COPYRIGHT

Equipment Schedule

Total System Capacity (kVA):
 (Rating of all inverters)
 Total Export Capacity (kVA):

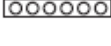
PV Inverter Details

Manufacturer:
 Model Name:
 Model Number:
 Rating (kVA):
 Total Number of Inverters:

Battery Inverter Details

Manufacturer: N/A
 Model Name: N/A
 Model Number: N/A
 Rating (kVA): N/A
 Total Number of Inverters: N/A
 Export capability: N/A

PV Panel Details

Manufacturer:
 Model Name/Number:
 Total Number of PV Panels:
 Individual Panel Rating (Watts):

Battery Details

Manufacturer: N/A
 Model Name/Number: N/A
 Rating (kWh): N/A

Export Limit Device

Manufacturer:
 Model Name:
 Model Number:

PV SLD – Example Single Line Diagram

Note: This Single Line Diagram is for Jemena purposes only. It is not intended for any other purposes and no liability is accepted for any items included or not included as required to meet Statutory or Regulatory compliance.
 All installation works shall comply with: AS/NZS 3000, AS/NZS 3008, AS/NZS 5033, AS/NZS 4777, CEC Guidelines, Victorian Service & Installation Rules and all Jemena Technical Standards.

Export Limit Setting ___ kVA

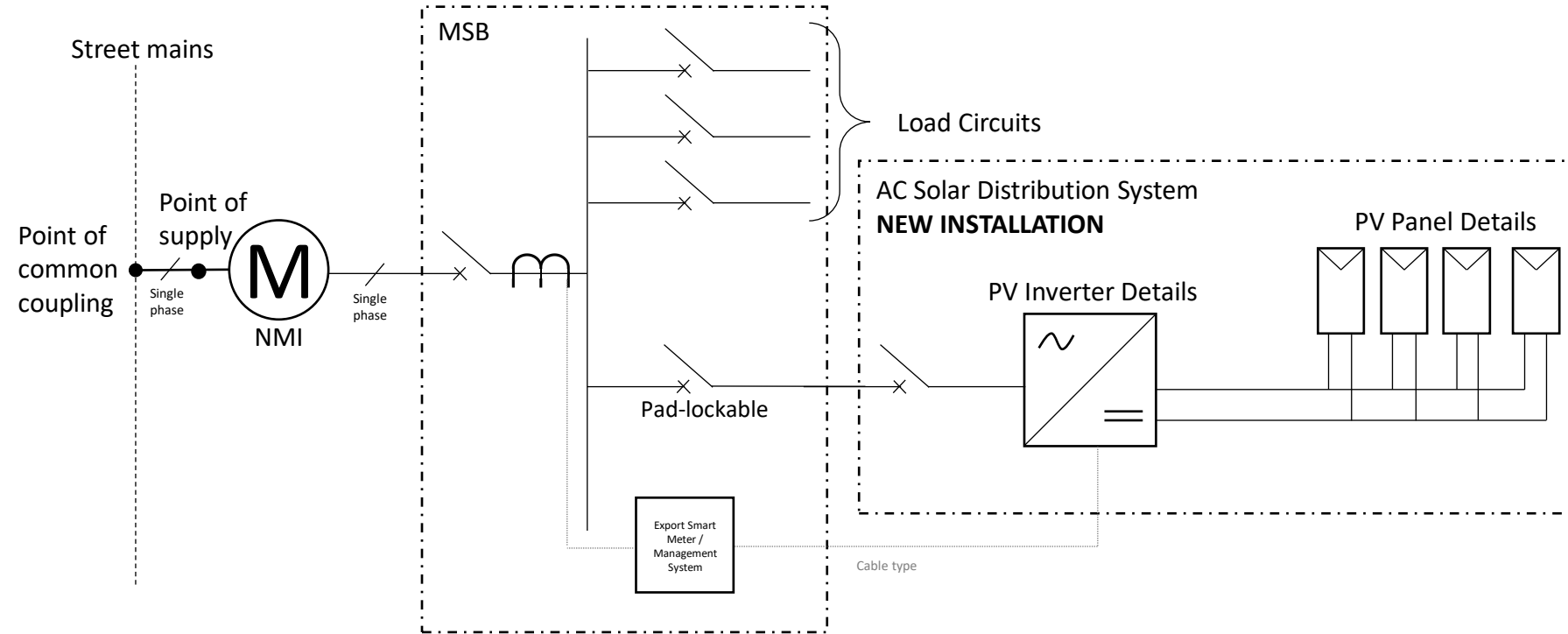

EXAMPLE

Installation Company:
 Address:
 Contact Number:
 Email:
 CEC Designer and Accreditation Number:

Project Name:
 Customer Name:
 Supply Address:
 NMI:

Prepared	Reviewed	Approved
Drawing No.	Date:	Rev.

Equipment Schedule

Total System Capacity (kVA):
 (Rating of all inverters)
 Total Export Capacity (kVA):

PV Inverter Details

Manufacturer:
 Model Name:
 Model Number:
 Rating (kVA):
 Total Number of Inverters:

Battery Inverter Details

Manufacturer:
 Model Name:
 Model Number:
 Rating (kVA):
 Total Number of Inverters:
 Export capability: yes/no

PV Panel Details

Manufacturer:
 Model Name/Number:
 Total Number of PV Panels:
 Individual Panel Rating (Watts):

Battery Details

Manufacturer:
 Model Name/Number:
 Rating (kWh):

Export Limit Device

Manufacturer:
 Model Name:
 Model Number:

PV+BESS SLD – Example Single Line Diagram (AC Coupled)

Note: This Single Line Diagram is for Jemena purposes only. It is not intended for any other purposes and no liability is accepted for any items included or not included as required to meet Statutory or Regulatory compliance. All installation works shall comply with: AS/NZS 3000, AS/NZS 3008, AS/NZS 5033, AS/NZS 4777, CEC Guidelines, Victorian Service & Installation Rules and all Jemena Technical Standards.

Export Limit Setting ___ kVA

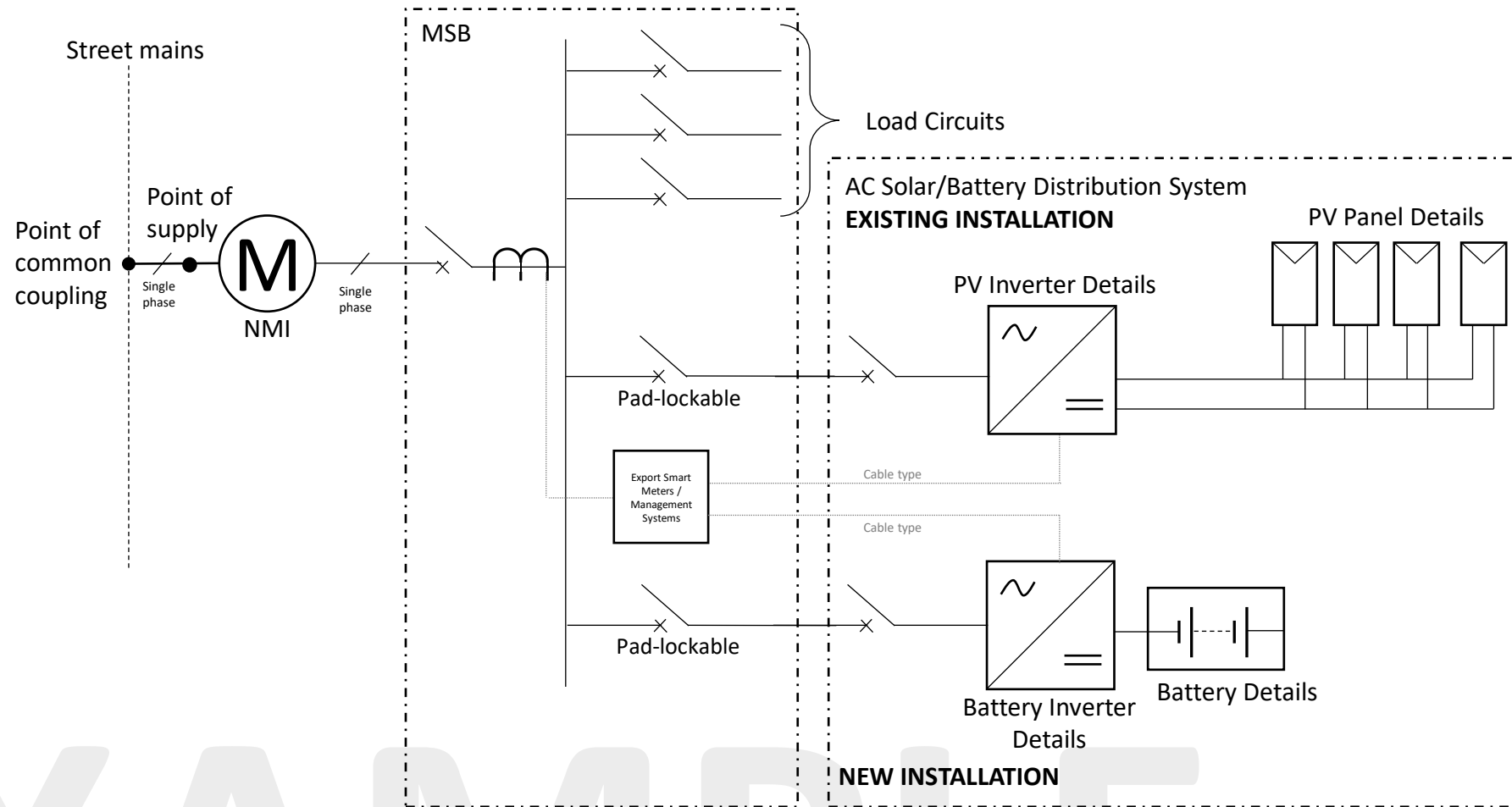

EXAMPLE

Installation Company:
 Address:
 Contact Number:
 Email:
 CEC Designer and Accreditation Number:

Project Name:
 Customer Name:
 Supply Address:
 NMI:

Prepared	Reviewed	Approved
Drawing No.	Date:	Rev.

Equipment Schedule

Total System Capacity (kVA):
 (Rating of all inverters)
 Total Export Capacity (kVA):

PV Inverter Details

Manufacturer:
 Model Name:
 Model Number:
 Rating (kVA):
 Total Number of Inverters:

Battery Inverter Details

Manufacturer: N/A
 Model Name: N/A
 Model Number: N/A
 Rating (kVA): N/A
 Total Number of Inverters: N/A
 Export capability: N/A

PV Panel Details

Manufacturer:
 Model Name/Number:
 Total Number of PV Panels:
 Individual Panel Rating (Watts):

Battery Details

Manufacturer:
 Model Name/Number:
 Rating (kWh):

Export Limit Device

Manufacturer:
 Model Name:
 Model Number:

PV+BESS SLD – Example Single Line Diagram (DC Coupled)

Note: This Single Line Diagram is for Jemena purposes only. It is not intended for any other purposes and no liability is accepted for any items included or not included as required to meet Statutory or Regulatory compliance.
 All installation works shall comply with: AS/NZS 3000, AS/NZS 3008, AS/NZS 5033, AS/NZS 4777, CEC Guidelines, Victorian Service & Installation Rules and all Jemena Technical Standards.

Export Limit Setting ___ kVA

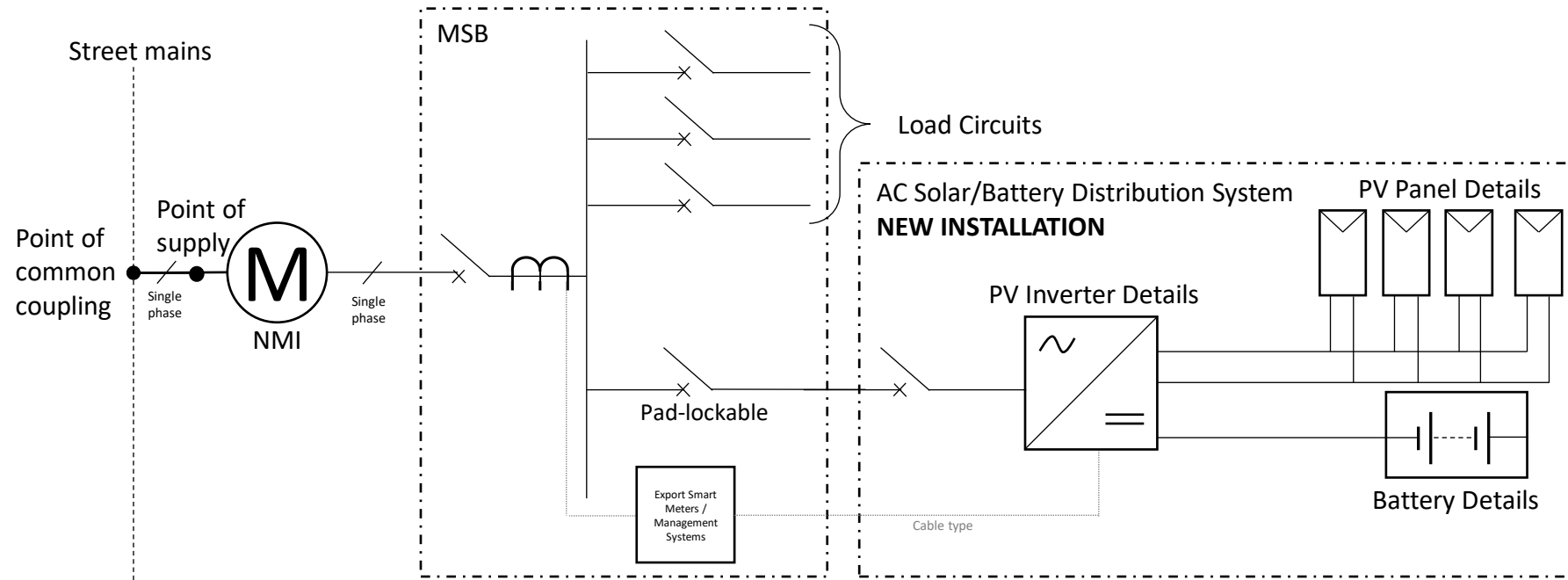

EXAMPLE

Installation Company:
 Address:
 Contact Number:
 Email:
 CEC Designer and Accreditation Number:

Project Name:
 Customer Name:
 Supply Address:
 NMI:

Prepared	Reviewed	Approved
Drawing No.	Date:	Rev.